

Chemical Storage Tanks

Fibreglass Solutions for Chemical Storage



Fibre reinforced plastic (FRP/GRP) tanks from Maskell are designed and built to offer you the most cost-effective chemical storage available. Maskell tanks are economical to buy, easy to install and require minimal maintenance. They're designed to resist corrosion in more than 2,000 different chemical environments.

Maskell has extensive experience in the construction of chemical storage tanks. This background, coupled with Maskell's 30 years of experience in the design, manufacture and application of FRP equipment including chemical storage tanks, yields tanks that feature state-of-the-art fibreglass construction technology.



This brochure shows you why Maskell tanks are your best long term answer to chemical storage, how our tanks are built, and how you can order the size and configuration to meet your chemical storage needs.

Structurally superior design

Computer-generated designs for Maskell tanks assure the proper combination of reinforcements to meet your performance criteria. Maskell tanks are designed to BS4994 and ASME RTP1 standards. That means longer life, less maintenance.



Quality assurance

In process quality control during each step of the manufacturing process assures greater reliability in service. Laminates must pass visual inspection, ultrasonic thickness testing, and Barcol hardness testing to assure proper laminate cure. Cut-outs of the laminate are statistically evaluated for glass content, and mechanical properties. Maskell quality assurance system is ISO9001 accredited.

Built to be cost-effective

Design and fabrication techniques keep initial cost low, lower than lined steel or alloy vessels of similar size. Maskell tanks also are constructed for ease of installation and low maintenance. Lighter weight means lighter and less expensive lifting equipment and foundations.



Economical because they're resistant to corrosion

Premium-grade isophthalic or vinyl ester resins with glass or synthetic reinforcements form a corrosion barrier that resists most aggressive chemicals. This means less maintenance, longer life.

Minimal maintenance

The non-corroding nature of fibreglass means Maskell tanks require little upkeep. The exterior requires no routine maintenance and is virtually unaffected by the environment or by chemical spills.

Chemical Storage Tanks

Maskell Filament Wound Tanks

- Built for Maximum Resistance to Corrosion

Maskell makes use of the latest in automatic equipment and fabrication techniques to produce the toughest laminate possible. The construction method combines the best features of hand layup and filament winding processes. The drawing shows how Maskell tank laminates are constructed to assure maximum strength and corrosion resistance.

Standard vertical tank walls are designed to a strain level of 0.2%. At ambient temperature, this results in a safety factor of 10 to 1 against failure.

INNER SURFACE - The inner surface is applied over a steel mandrel or mould surface to assure maximum chemical resistance. It consists of layers of glass or synthetic veil uniformly wetted with a premium grade resin to a 0.75mm thickness which is approximately 90% resin.

INNER LAMINATE - The same premium grade resin used in the inner surface is applied with randomly chopped glass to form a 2mm thick inner laminate. The **INNER SURFACE** and the **INNER LAMINATE** combined are typically called the **CORROSION BARRIER**. This 2.75mm barrier offers maximum resistance to a wide range of chemicals.

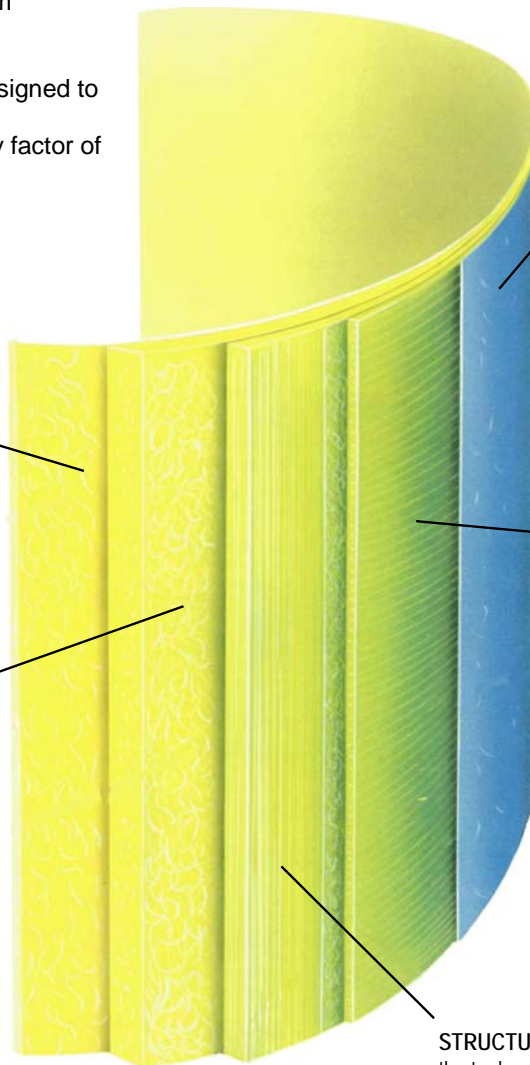

EXTERIOR SURFACE - This isophthalic resin-rich layer is resistant to chemicals and protects against most spills. Ultraviolet stabilisers inhibit material degradation. Several pigmented gelcoat colours are available.

EXTERNAL LAMINATE - It consists of layers of glass or synthetic veil uniformly wetted with a premium grade resin to a 0.75mm thickness which is approximately 90% resin.

STRUCTURAL LAMINATE - The strength of the tank against internal and external loads is provided by a high strength, continuous filament laminate. The filament wound construction consists of several layers of continuous reinforcement wrapped around the tank.

MASKELL PRODUCTIONS LIMITED

24 Bowden Road, Mt. Wellington, PO Box 11-185, Auckland 5, New Zealand.

Phone +64-9-573-0548, Fax +64-9-573-0666.

Email: info@maskell.co.nz Website: www.maskell.co.nz

Chemical Storage Tanks

Maskell Tank Fittings and Accessories

- Suit your individual specifications

Maskell can supply the accessories and fittings your application demands. This illustration shows some standard accessories available; additional parts and modifications are available to fit your applications and specifications

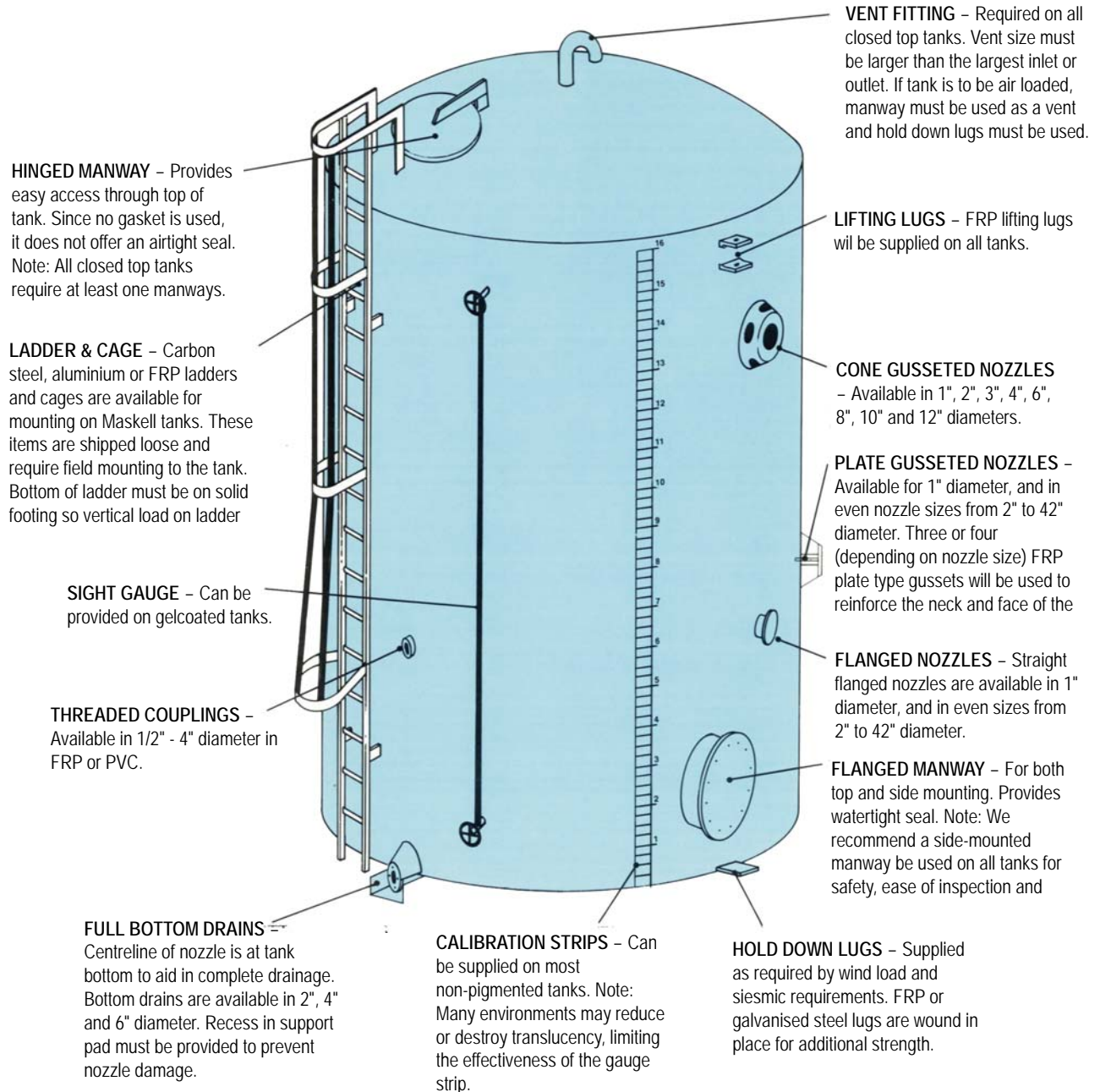

MASKELL PRODUCTIONS LIMITED

24 Bowden Road, Mt. Wellington, PO Box 11-185, Auckland 5, New Zealand.

Phone +64-9-573-0548, Fax +64-9-573-0666.

Email: info@maskell.co.nz Website: www.maskell.co.nz

Chemical Storage Tanks

Guide to the Selection of Standard Chemical Tanks

Vertical Flat-Bottom Tanks

Normal capacities from 1500 to 250,000 litres are available from the standard line of flat-bottom tanks. These tanks are designed for atmospheric (non-pressure / non-vacuum) storage of liquids with maximum temperatures to 82°C in many environments.

Actual Litre Capacity	Inside Diameter (mm)	Open Top Height (mm)	Closed Dish Top Height (Nom.)	Actual Litre Capacity	Inside Diameter (mm)	Open Top Height (mm)	Closed Dish Top Height (Nom.)
1,500	1200	1400	1600	16,000	3000	2100	2700
3,000	1200	2700	3000	20,000	3000	2700	3300
5,000	1200	4300	4500	23,000	3000	3200	3800
2,000	1500	1400	1700	31,000	3000	4300	4800
4,000	1500	2100	2400	39,000	3000	5300	5900
6,000	1500	3200	3500	46,000	3000	6300	6800
7,500	1500	4300	4600	61,000	3000	8400	8900
4,000	1800	1500	1900	23,000	3500	2600	3200
6,000	1800	2300	2600	31,000	3500	3500	4100
8,000	1800	2900	3200	39,000	3500	4400	5000
12,000	1800	4400	4800	46,000	3500	5200	5800
15,000	1800	5800	6100	54,000	3500	6100	6700
6,000	2000	1700	2100	62,000	3500	7000	7600
8,000	2000	2100	1500	77,000	3500	8700	9300
10,000	2000	2700	3100	91,000	3500	10400	11000
12,000	2000	3400	3700	30,000	4000	2900	3600
15,000	2000	4300	4000	38,000	4000	3700	4300
20,000	2000	5500	5900	46,000	4000	4400	5100
23,000	2000	6400	6800	61,000	4000	5800	6500
11,000	2500	2400	2900	77,000	4000	7300	8000
15,000	2500	3100	3500	91,000	4000	8700	9400
23,000	2500	4900	5200	114,000	4000	10800	11500
30,000	2500	6400	7000				
38,000	2500	8200	8700				

Please note that the diameters and heights given above a guide only. Maskell productions has built tanks up to 6.5m in diameter. Overall size of the vessel is only limited by the ability to transport to site economically.

Chemical Storage Tanks

Guide to the Selection of Standard Chemical Tanks

Dish-Bottom, Leg Supported Tanks

Standard dished-bottom tanks are available for atmospheric storage of liquids to a maximum of 82°C for many environments. Tanks are supplied in open top, dished top, or flat cover configurations. Support of tanks is accomplished with FRP or epoxy-coated, carbon steel legs. The 1200mm diameter tanks are used three legs 120° apart. 1500~2500mm diameter use for four legs 90° apart and 3500~3500mm diameter tanks use six legs, 60° apart. Standard clearance from tank bottom to pad is 500mm with other clearance available. Tanks can be supplied with flush centre drains for cleaning or for product drainage.

Actual Litre Capacity	Inside Diameter (mm)	Open Top Height (mm)	Closed Dish Top Height (Nom.)
2,000	1200	2200	2400
4,000	1200	3600	3800
5,000	1200	5000	5200
4,000	1800	2200	2500
6,000	1800	2900	3000
7,000	1800	3500	3900
12,000	2500	3300	3700
15,000	2500	3900	4300
16,000	3000	2800	3400
19,000	3000	3100	3900
25,000	3000	3900	4500
31,000	3000	5000	5600
31,000	4000	3700	4400
40,000	4000	4500	5200
45,000	4000	5100	5800

Standard clearance – 460mm bottom to foundation.

Additional capacities and tank diameters-5, 7, 9 & 11 feet are available.

Above-Ground Horizontal Tanks

Available in nominal capacities from 500 to 15,000 gallons. These tanks will handle many environments to 160°F maximum operating temperature. Standard design is for non-pressure / non-vacuum (atmospheric) service. Standard tank support is two, FRP or epoxy-coated, carbon steel saddles. Nominal saddle height is 100mm. Additional sizes and capacities are available. A complete line of tanks for underground chemical services are also available from Maskell.

Actual Litre Capacity	Inside Diameter (mm)	Length (mm)
2,000	1200	1800
3,000	1200	2900
4,000	1200	3500
6,000	1800	2400
8,000	1800	3200
11,000	1800	4600
12,000	2500	2800
15,000	2500	3600
20,000	2500	4500
23,000	2500	5300
24,000	3000	3700
31,000	3000	4200
38,000	3000	4200
23,000	4000	2700
31,000	4000	3500
39,000	4000	4200
47,000	4000	5000
56,000	4000	5900

Chemical Storage Tanks

TANK MODIFICATIONS...

Covers and Heads

Standard vertical tanks come with integral dish tops or open top. If required to suit individual applications. Maskell can supply removable flat or dished covers. In these cases a 2" lip is provided to fit over tank edge.

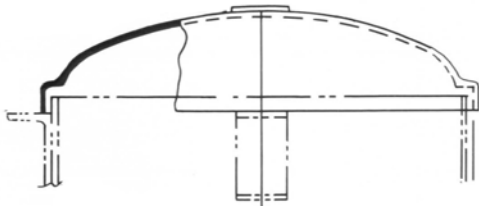

REMOVABLE DISH TOP

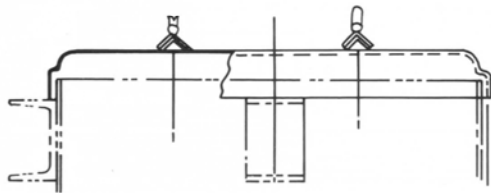

FLAT REMOVABLE COVER -In addition the covers can be adapted for flange mounting. Flat covers can be split and/or hinged.

Bottoms

Vertical tanks are normally supplied with flat bottoms. Process requirements sometimes dictate the need for full drainage of the tank. To facilitate drainage and cleaning Maskell offers both external and internal sloped bottom tanks. Standard bottom designs are as follows.

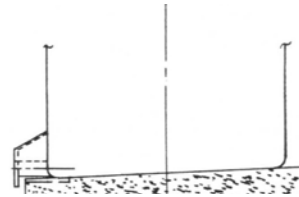

NATURAL SLOPED BOTTOM TANK-2" or 4" maximum cant, pad to match cant of bottom.

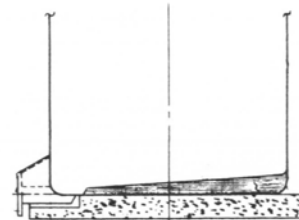

INTERNAL SLOPED BOTTOM TANK-Standard slope is 6.35mm / ft. Side manway is required on all internal sloped-bottom tanks. Where full drain nozzles are supplied, concrete must not contact drain nozzle or reinforcing.

Chemical Storage Tanks

ACCESSORIES...

AGITATION EQUIPMENT & BAFFLES

A variety of agitator mounting nozzles, bridges and supports are available to suit most mixing requirements. Internal baffles and baffle supports are available for agitated tanks to insure proper mixing. Supports are required at the top and bottom of the baffle and a maximum of every 4" of length.

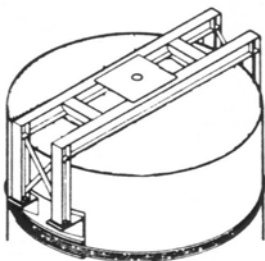

Typical Agitator Bridge Installation

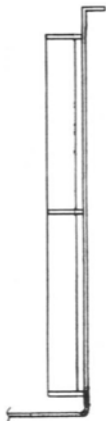

Baffle Detail

LIFTING LUGS

FRP or galvanised steel listing lugs are supplied with each tank. One lug will align with a hold down lug for ease of handling and uploading.

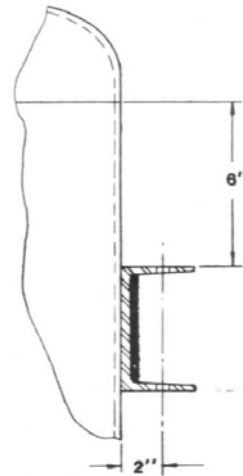

HOLD DOWN LUGS - Hold down lugs as shown are supplied on all flat bottom vertical tanks. Lugs must be used if tanks are air loaded or subject to wind and resistance loading.

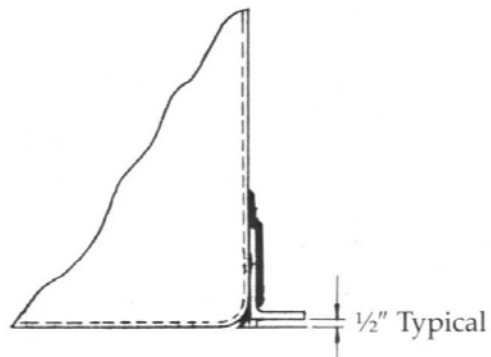

Note: Modifications and accessories shown in this bulletin reflect some of the most frequently requested items. For a complete list of standard accessories or to discuss custom tank fabrication, please contact your Maskell chemical tank representative.

Chemical Storage Tanks

ACCESSORIES

LADDERS, SAFETY CAGES & PLATFORMS

Carbon Steel or FRP Ladders, Safety Cages and Platforms are available for Maskell tanks. Ladders, cages and platforms arrive loose for field assembly to tank once it has been set in place. Ladders are designed for full foundation supports. Top safety platforms, hand rails, transition platforms and gates are also available.

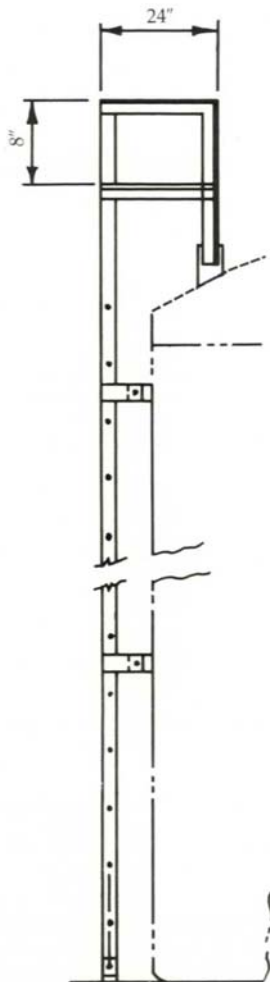

Typical Ladder Installation

TANK INSULATION AND HEATING

Tanks can be supplied with 50mm of polyurethane foam insulation (25mm on 1200 and 1500mm dia. Tanks). Foam core is protected with a weather and spill resistant 3mm chopped glass and resin exterior overlay. Standard exterior cover pigmentation is gray or white. Tanks insulated in this manner have a U factor of $0.271 \text{ s A}^2 / \text{m}^2$.

Insulated tanks can be supplied with resistance type heating panels or tracing tape. Heating systems are ideal for applications where product must be kept from freezing or where a sustained elevated temperature is desired (max. 120°F). Suitable temperature monitoring devices should be installed on all heated tanks.

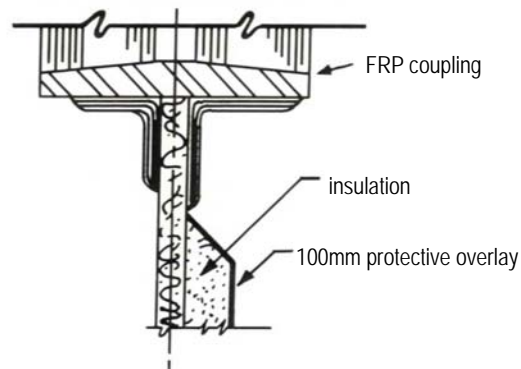

Tank wall cross-section with insulation and overlay

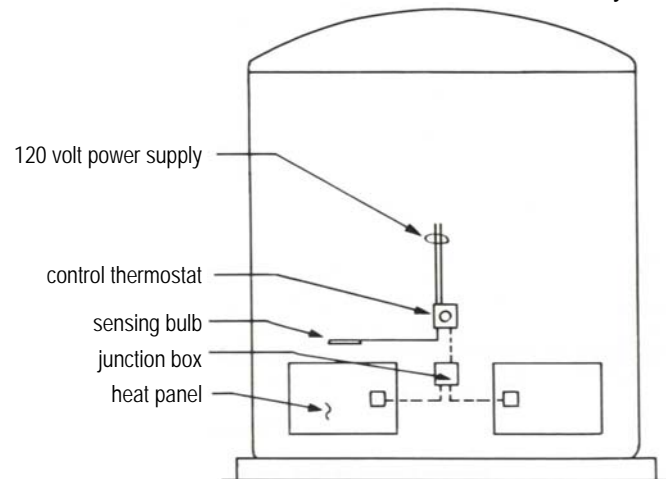

Typical Application of Heat Panels